

Plattendicke: 1,7 mm

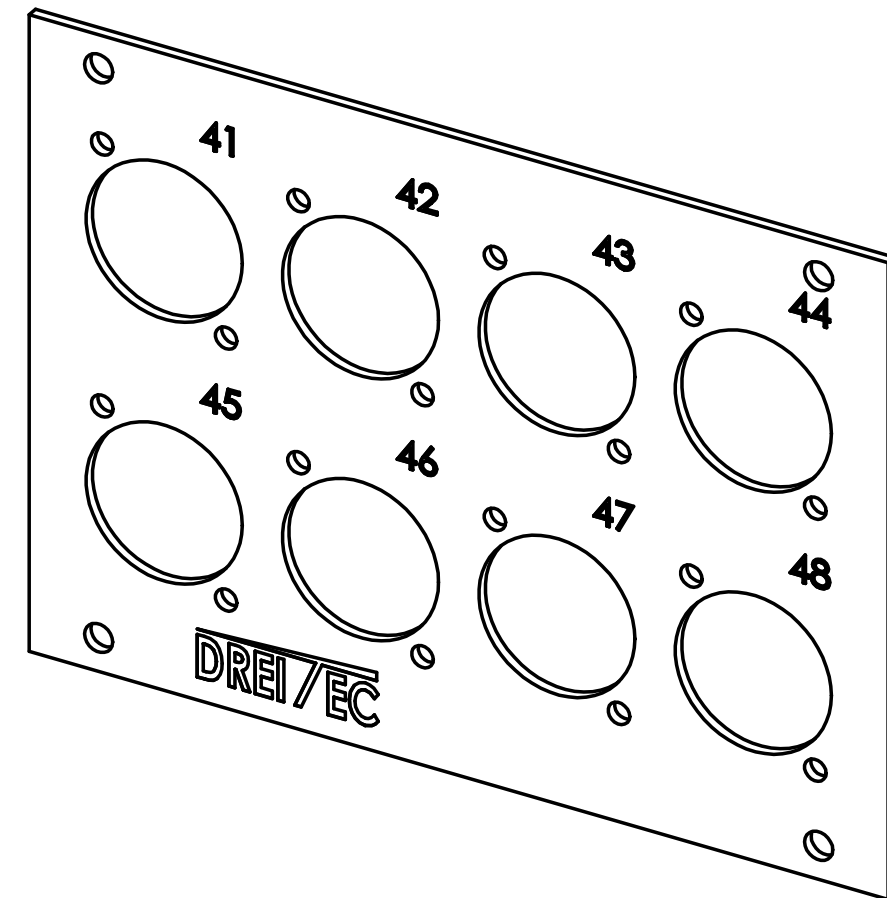

DREI/EC				Maßstab		1:1	
		Datum	Name	9940/ 41-48			
	Bearb.	08.04.2011	Denzler				
	Gepr.						
	Norm						
				DREISSIG TECHNOLOGY GmbH & Co.KG Breitenlöher Weg 22 D-91166 Georgensgmünd			
				Tel. : +49 (0) 9172-68543-0 Fax : +49 (0) 9172-68543-50			
Zust	Änderung	Datum	Name				